

BMR PLA 33

Power line analyzer

User and service manual



version 1.6

Content

1. Front control panel and terminal plate.....	3
2. Device description.....	4
3. Device connection.....	5
4. Setting in operation – fast start.....	6
5. Function description.....	6
6. Parameter setting.....	6
6.1. Main configuration settings – menu P_1.....	6
6.1.1. Utr – voltage transformer ratio.....	7
6.1.2. Itr – current transformer ratio.....	7
6.1.3. Input / output configuration.....	7
6.1.4. Power and current demand setting.....	8
6.1.5. Internal calendar and clock.....	8
6.2. Second menu P_2.....	9
6.2.1. Communication interface RS485.....	9
6.2.2. System frequency setting.....	9
6.2.3. Password protection against unauthorized configuration.....	9
6.2.4. Display back-light configuration.....	9
6.2.5. Reset to the default factory setting.....	10
6.2.6. Recording to flash memory.....	10
6.2.7. Load profile recording.....	10
6.3. Alarm menu – AL.....	10
6.3.1. Comparator definition.....	11
7. Normal monitoring mode.....	12
7.1. Operation and symbol meanings.....	12
7.2. Maximum and minimum values.....	12
7.3. Demand values.....	12
7.4. Energy counters.....	13
7.5. Monitoring screens.....	14
8. Technical features.....	16

1. Front control panel and terminal plate

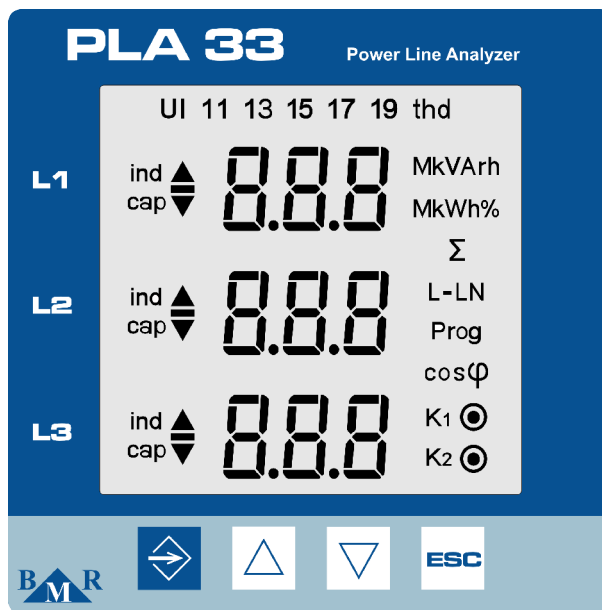

Picture 1: Front panel description

1. – key for setup menu entrance and saving set parameters
2. – cursor key for moving up in menu and parameter change to higher value
3. – cursor key for moving down in menu and parameter change to lower value
4. – ESC key for canceling or return

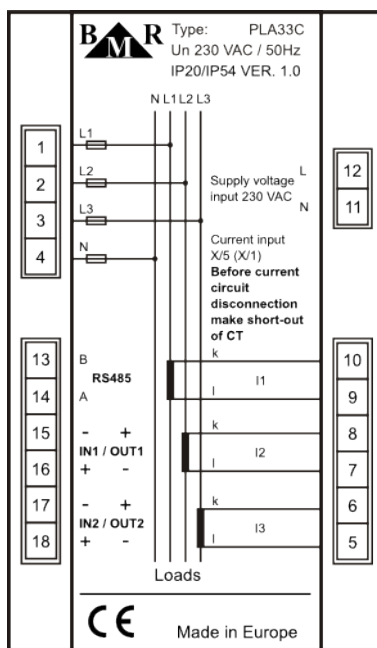

Picture 2: Terminal plate

2. Device description

Power line analyzer PLA33 is designed for monitoring of electrical parameters of three-phase or single-phase low voltage and medium voltage power grids. PLA33 analyzer design is based on fast 16 bits microprocessor which provides precise measurement with fast sampling of 128 samples per period at each phase. According to the norm EN 50160, the current and voltage is measured continually at all three phases and at every period.

Parameter	L1	L2	L3	Σ	min	max	Measuring range	Displaying range	Accuracy
Phase voltage, L – N	•	•	•		•	•	0 ... 300 VAC	0 ... 180 kV	±0,5 % MR
Phase to phase voltage, L – L	•	•	•		•	•	0 ... 520 VAC	0 ... 312 kV	±0,5 % MR
System frequency	•					•	40 ... 70 Hz	40 ... 70 Hz	±0,2 % MV
Current	•	•	•			•	0,01 ... 6 A	0 ... 7,5 kA	±0,5 % MR
Current in neutral, N				•		•	-	0 ... 7,5 kA	±1,5 % MR
Power factor				•		•	0,01 ind. ... 0,01 cap.	0,01 ind. ... 0,01 cap.	±1,0 % MR
cosφ	•	•	•			•	0,01 ind. ... 0,01 cap.	0,01 ind. ... 0,01 cap.	±1,0 % MR
Total harmonic distortion of voltage, THDU	•	•	•			•	0 ... 999%	0 ... 999%	±1,0 % MR
Total harmonic distortion of current, THDI	•	•	•			•	0 ... 999%	0 ... 999%	±1,0 % MR
Partial odd harmonics of voltage (1 - 19) in %	•	•	•			•	0 ... 999%	0 ... 999%	±1,0 % MR
Partial odd harmonics of current (1 - 19) in %	•	•	•			•	0 ... 999%	0 ... 999%	±1,0 % MR
Apparent power, S	•	•	•			•	0 ... 1,8 kVA	0 ... 999 MVA	±1,0 % MR
Active power take-off / supply, P	•	•	•			•	0 ... 1,8 kW	0 ... 999 MW	±1,0 % MR
Reactive power take-off / supply, Q	•	•	•			•	0 ... 1,8 kVAr	0 ... 999 MVAr	±1,0 % MR
Apparent power, sum S				•		•	0 ... 5,4 kVA	0 ... 999 MVA	±1,0 % MR
Active power take-off / supply, sum P				•		•	0 ... 5,4 kW	0 ... 999 MW	±1,0 % MR
Reactive power take-off / supply, sum Q				•		•	0 ... 5,4 kVAr	0 ... 999 MVAr	±1,0 % MR
Active energy take-off / supply				•		•	0 ... 9 999 999 kWh	0 ... 9 999 999 kWh	Class 1*
Reactive (inductive) energy take-off / supply				•		•	0 ... 9 999 999 kVAh	0 ... 9 999 999 kVAh	Class 1*
Reactive (capacitive) energy take-off / supply				•		•	0 ... 9 999 999 kVAh	0 ... 9 999 999 kVAh	Class 1*

* for ideal sinusoidal curve of voltage and current

Table 1: Measured and displayed parameters

PLA33 analyzer is available in four types according to the following table 2. All types of PLA33 analyzer measure parameters according to table 1.

Analyzer type	Communication interface RS485	Programmable inputs / outputs	Internal data flash memory	Power cuts memory	Power supply voltage 230 VAC	Voltage and current measurement according EN50160	Display back-light appending B
PLA33 L					•	•	○
PLA33		•			•	•	○
PLA33 C	•	•		•	•	•	○
PLA33 CM	•	•	•	•	•	•	○

Table 2: Analyzer types

3. Device connection

Default parameters, according to table 3, are set to the device in production. The level and type of used power supply voltage has to be the same as it is written on the terminal plate label. By default the power supply voltage is 230 VAC 50 Hz (+10%, -15%).

Voltage measurement circuits as well as power supply input have to be connected via circuit breaker or power switch and fuse (2 ... 10 A) which are placed close to the device for easy access. Current measurement circuits have to be connected via current transformers, either $..5A$ or $..1A$ ratio.

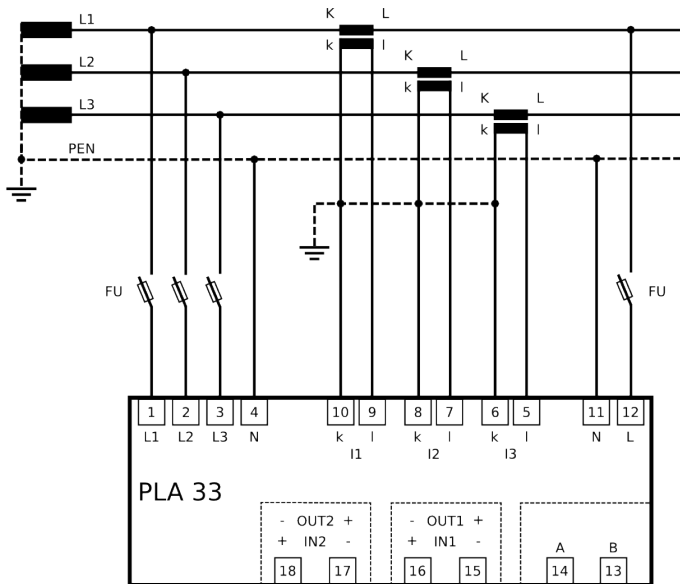

Picture 3: Three-phase measurement at TN-C network

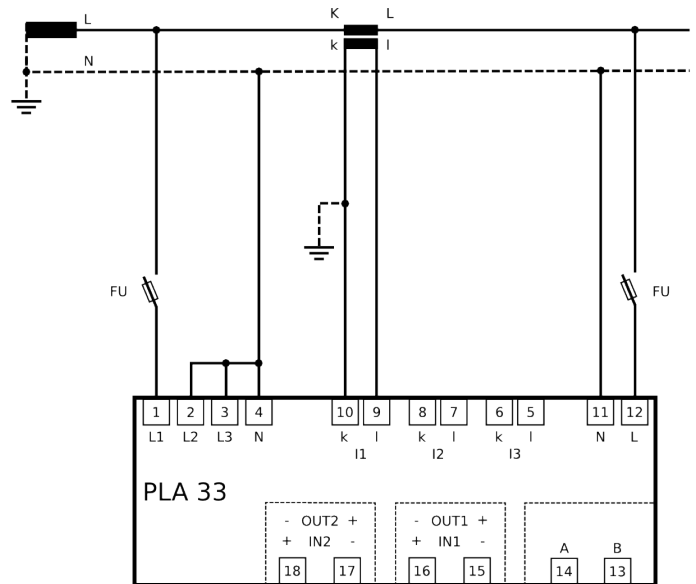

Picture 4: Single-phase measurement

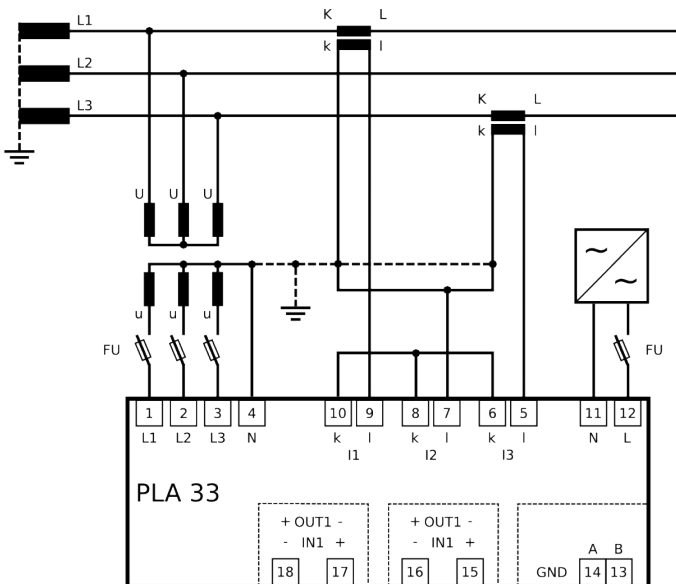

Picture 5: Connection at medium voltage network

4. Setting in operation – fast start

Setting PLA33 analyzer in operation is very easy although there is list of parameters than can tune device for various applications. For fast commissioning of the PLA33 analyzer follow next instructions.

1. Make connection according to connection diagram at picture 3.
2. Connect the right level of power supply voltage according the label on back side of device and turn the power supply on.
3. Press button **SET** for the time at least 5 seconds. After that, device will switch to the configuration mode.
4. Enter the menu **P_1** by pressing button **SET** on it.
5. Set the voltage transformer ratio in the parameter **Utr** in case that voltage transformer is used. Key **▲** is used for moving in menu. Key **Set** enable parameter setting. For changing of the ratio value use keys **▲ (+)** and **▼ (-)**. Newly set ratio confirm by pressing key **Set**.
6. Set the current transformer ratio in the parameter **Itr**. For changing of the ratio value use keys **▲ (+)** and **▼ (-)**. Newly set ratio confirm by pressing key **Set**.
7. Press the key **ESC** to close configuration menu **P_1**. Another pressing of key **ESC** will turn device back to normal monitoring operation.

5. Function description

Device digitizes continually (period by period) measured true RMS values of voltage and current in three-phase network according to the norm EN 50160. Values on the display are updated every second. Maximums of measured values as well as energy values are stored into nonvolatile memory. For the model PLA33CM with internal 512 MB flash memory the selected variables are also stored into that memory with the minimum recording period of 200 ms.

6. Parameter setting

Configuration of power line analyzer PLA33 is divided into the three menus. For entering the configuration mode press key **SET** for at least 5 seconds. After that following screen appears on the display.

For moving in the menu use cursor keys **▲** and **▼**. Key **▲** is normally used for circle moving in the menu. Parameters setting is activated by pressing the key **SET**. Changing the parameter setting is done by cursor keys **▲** and **▼**, confirmation of newly set parameter value by key **SET**. Key **ESC** cancels setting or move back to higher menu or back to normal operation.

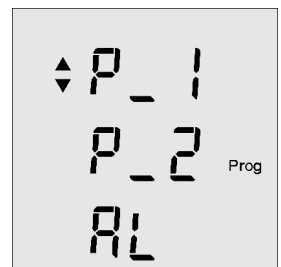

Parameter	Description	Factory setting	Setting range
P_1	main configuration settings	▶	▶
P_2	communication parameters settings	▶	▶
AL	alarms settings	▶	▶

Table 3. Configuration mode menu

6.1. Main configuration settings – menu P_1

In the main configuration menu, it is possible to set essential parameters for correct function of PLA33 analyzer. In the table 4, there is the list of parameters available at the menu **P_1**. For moving in the menu use cursor key **▲**. By pressing the key **SET** enter the parameter configuration where changing the parameter value is possible by cursors keys **▲** and **▼**. Confirmation of set parameter is done by press of key **SET**. Key **ESC** cancels the parameter configuration while keeping initial setting.

Parameter	Description	Factory setting	Setting range
Utr	voltage transformer ratio	1	1 ... 1500
Itr	current transformer ratio	1	1 ... 1500
In	K1 1 st output / input setting	In	In, Out, PuL, AL
In	K2 2 nd output / input setting	In	In, Out, PuL, AL
t_A	time for maximum demand averaging calculation		1 ... 60 min
C_A	power and current demand setting		S_A, F_A
Y--	internal calender – year setting 20--	9	9 ... 99
Π--	internal calender – month setting	1	1 ... 12
d--	internal calender – day setting	1	1 ... 31
h--	internal clock – hour setting	0	0 ... 23
Π--	internal clock – minute setting	0	0 ... 59
ΠA	maximums of measured parameters	OFF	OFF / On
ΠCL	reset of all energy meters	-	-

Table 4. Main configuration menu P_1

6.1.1. Utr – voltage transformer ratio

If the voltage transformer is used, for example MV applications, according to connection diagram on picture 5, it is necessary define transformer ratio for correct operation.

It is important to have in mind that the value which is set, is ratio itself. It means that, for example, if primary voltage 6000 V and secondary voltage is 100 V then set value is 60.

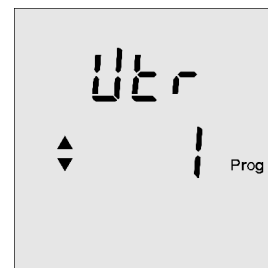

6.1.2. Itr – current transformer ratio

It is important to have in mind that the value which is set, is ratio itself. It means that, for example, if primary nominal current of current transformer is 50 A and secondary is 5 A then set parameter value is 10.

Caution

Measurement range of the current inputs is from 10 mA to 6 A. Maximum of the current transformer ratio is 7500/5 A.

6.1.3. Input / output configuration

Device is equipped by two output / input terminals. Definition how the terminal will behave is fully programmable. By default terminal behavior as input is set. In the configuration menu P_1 the setting of input / output terminal is on the third and fourth position. It is represented by shorter of status and by symbol K₁ for input/output No. 1 and by symbol K₂ for input/output No. 2.

Every input/output can be set independently on other. Connection example of combination of one input and one output is show on the picture 6. Polarity of voltage is changing according to usage of input or output. Check carefully device label.

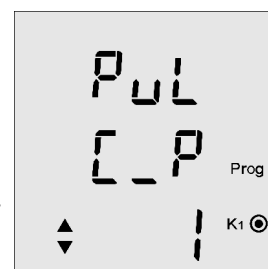

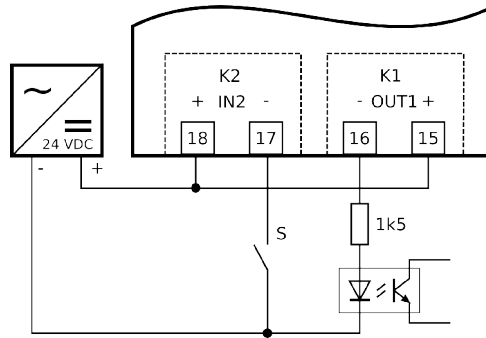

Picture 6. Connection of PLA 33 input and output

PLA33 can work as an energy meter with pulse outputs. Pulses can represent any of measured energy, consumption or supply. After selecting of pulse output **PuL** the requested energy counter is chosen at the second line. Last step is to define the weight of the pulse output at the third line. Weight is define in range from 1 ... 500 Wh.

Parameter	Description	Factory setting	Setting range
In	input controlled by PC	-	-
Out	output controlled by PC	-	-
PuL	C_P pulse output – active energy consumption	1	1 ... 500 Wh
PuL	C_L pulse output – reactive inductive energy consumption	1	1 ... 500 Wh
PuL	C_C pulse output – reactive capacitive energy consumption	1	1 ... 500 Wh
PuL	S_P pulse output – active energy supply	1	1 ... 500 Wh
PuL	S_L pulse output – reactive inductive energy supply	1	1 ... 500 Wh
PuL	S_C pulse output – reactive capacitive energy supply	1	1 ... 500 Wh
AL	alarm output	-	definition at chapter 6.3

Table 5. Input / Output configuration states

6.1.4. Power and current demand setting

PLA33 is equipped by demand feature for phase current, three-phase apparent power and three-phase active power. Demand feature is defined by period for averaging in the parameter **t_A** which can be set from 1 ... 60 minutes.

Another parameter **C_A** defines the method for calculation of demand.

Parameter	Setting	Description
C_A	S_A	static window for averaging according to defined averaging time in parameter t_A
	F_A	flow window for averaging with window time defined in parameter t_A

6.1.5. Internal calender and clock

Versions of PLA33 with communication interface are equipped by internal real time clock and calender. Setting of the time and date is available in configuration menu by editing parameters visible on the two screens.

Moving cursor on the parameter by key ▼ and pressing **SET** enters the setting. First screen in order is date setting (Year / Month / Day) and after pressing the key ▲ the second screen of time setting (Hour / Minute) will appear.

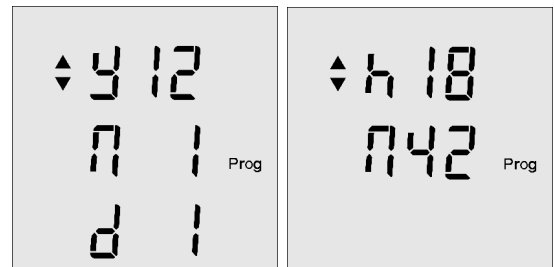

6.2. Second menu P_2

Second menu **P_2** groups parameters for communication setting, system frequency and reset to the default factory setting.

Parameter	Description	Factory setting	Setting range
Id	device identification number in RS485 network	0	0 ... 255
bd	communication speed for data transmission	9,6	9,6 / 19,2 / 38,4 / 57,6 / 115 kBd
PAr	communication control by parity checking	---	--- (none), <u>_o_</u> (odd), <u>_E_</u> (even)
St	stop bit	1	1 / 2
Fr	system frequency Hz	50	50 / 60 Hz
PAS	password	---	any number in the range 001 – 999
bcL	display backlight	On	On, OFF, 30 ... 300 second
cnt	display contrast	100%	30 ... 100%
rES	reset to default factory setting		
S_Π	information about running recording to memory*	Off	On – recording in process
S_P	Information about enabled last profile*	Off	On – recording in process

Table 6: Second configuration menu **P_2**

6.2.1. Communication interface RS485

Device can be equipped by serial interface RS485 for communication with PC or other devices. In the second menu there is possibility to define communication parameters as they are described in table 6.

Id – identification number defines the number of device in the RS485 network and has to be unique within the network. **bd** – communication speed defines communication speed between the PLA33 device and PC. **Par** – parity control is by default disabled and it can be changed to even (_E_) or odd (_o_). Communication speed and parity control has to be identically set to the same values at device and RS485 converter.

6.2.2. System frequency setting

In order to assure the best performance and measurement accuracy the device is by default tuned to sample voltage and current in network with system frequency of 50 Hz. Nevertheless it is designed also for systems which works with 60 Hz frequency. To obtain the best performance from PLA33 analyzer set the system frequency according to your system by editing the parameter **Fr**.

Caution

System frequency should be changed only in case that the system works in 60 Hz system. Default setting of 50 Hz complies with system in most of the countries around the world.

6.2.3. Password protection against unauthorized configuration

Device is possible to be protected against unauthorized configuration changes by three digit password. Entering the parameter **PAS** and activating the password setting by key **SET** opens definition of the first number of password. By key **▲** number is defined while key **▼** moves cursor to another digit. Password is confirmed by key **SET**. Erasing the password is possible by setting the 000.

6.2.4. Display back-light configuration

Display back-light can be adjust to give the best performance according to light condition at place of installation. Contrast of display is adjustable by parameter **cnt** from 30% ... 100% in step of 10%. It is also possible to set the back-light behaviour. Back-light can be enabled permanently, disabled or active only for certain time, adjustable from

30 ... 300 s, from last activity on the keyboard.

6.2.5. Reset to the default factory setting

There is possibility to turn PLA33 analyzer back to the default factory setting. In the second menu is available parameter **rES**. By pressing the key **SET** on this parameter, device erases all settings except the real time clock and calender and sets default factory setting.



Important

After reset to the default factory setting the all user configurations are lost. It is necessary to set at least transformer ratio of current and voltage transformer.

6.2.6. Recording to flash memory

Device PLA33CM has internal flash memory for recording of measured parameters. Setting and starting the measurement is possible from PMS software only. Up to 10 parameters (1 parameter means for example all phase currents) can be recorded with recording period adjustable from 200 ms to 60 minutes. Since the measurement is downloaded via RS485 line it is important select proper recording period to limit the file size. For example, the recording over the month it is recommended to have recording period 15 minutes. Time of download to PMS software depends on the communication speed set in device and converter.

Running measurement is identified in PLA33CM under informative parameter **S_Π** and its status On / Off.



Caution

Measurement recording to flash memory is backup-ed for power cuts up to 12 hours length. If the power cut is longer the measurement recording can be lost or contain some errors and incorrect data.

6.2.7. Load profile recording

For device PLA33CM it is possible (from PMS software) start load profile recording into two blocks of flash memory. Recording period is defined by the time of averaging in the parameter **t_A** and it is adjustable from 1 ... 60 minutes. Every **t_A** time the values or all energy meters are recorded to memory until the reserved space left. Then the data from complete block are deleted and new recordings are stored.

For example for 15 minutes recording period the two blocks of flash memory are able keep approximately about 80 days of load profile. Keeping the load profile consistent it is necessary to manage regular download of data before the time left.



Caution

Load profile recording is backup-ed for power cuts up to 12 hours length. If the power cut is longer the load profile data can be lost and it is necessary create the new load profile by PMS software.

6.3. Alarm menu – AL

Device is equipped by two input / output terminals which can be programmed to the four different states. If the terminal one or two is set, according to the setting in menu **P_1**, to work as an alarm output. Every output, while is set to behave as an alarm, consists from three comparators. Comparators are sorted into logical function according to following picture.

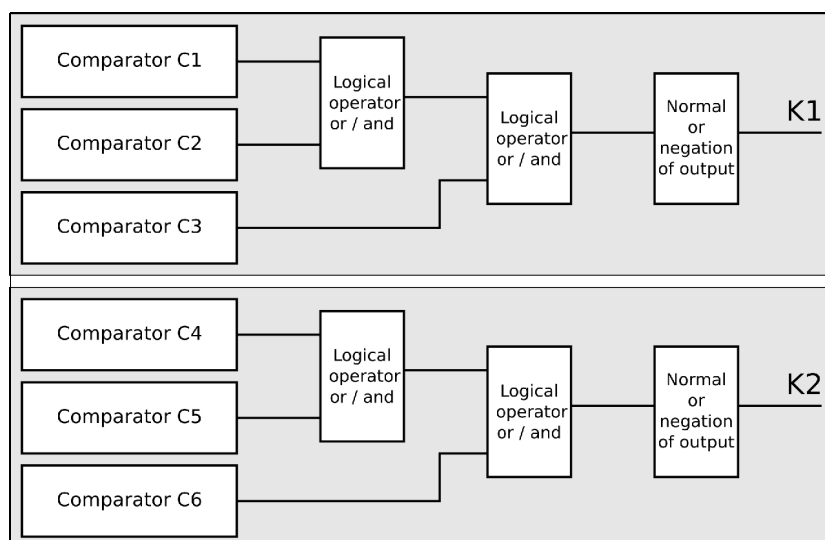

Picture 7. Comparators and logic functions

Comparators C1, C2 and C3 belongs to the output K1 and comparators C4, C5 and C6 to output K2. From the picture 7 is visible that there are logical function between first two comparators of the group and between their result and last comparator of the group. There are two logical operators available, logical conjunction – AND and logical disjunction – OR.

Logical output can be in also inverted or in normal position. By default it is set to behave as normal.

Ch123 – output K1		Ch456 – output K2	
Logical operator	Meaning	Logical operator	Meaning
u_u	(C1 OR C2) OR C3	u_u	(C4 OR C5) OR C6
u_n	(C1 OR C2) AND C3	u_n	(C4 OR C5) AND C6
n_u	(C1 AND C2) OR C3	n_u	(C4 AND C5) OR C6
n_n	(C1 AND C2) AND C3	n_n	(C4 AND C5) AND C6
nor	normal logical output	nor	normal logical output
inr	inverted logical output	inr	inverted logical output

Table 7: List of logical function combination and output states

6.3.1. Comparator definition

Each comparator can be set to work with any parameter listed in the table 8. Chosen parameter is compared if it is < or > than set value level. For every comparator there are three screens in the menu **AL** in the setting mode. By default every comparator is disabled and introduced by symbol **OFF**.

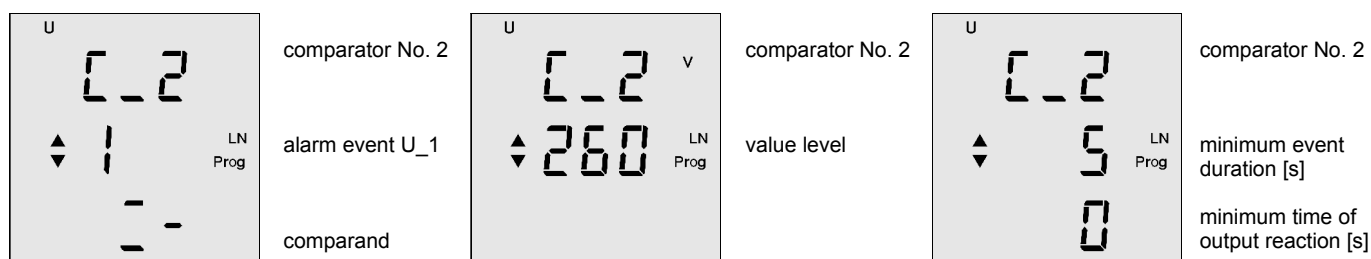

Picture 8. Comparator definition screens

At the first screen of appropriate comparator the compared parameter is selected and it is defined the operation. Second screen defines the value level of compared parameter in real values. Third screen is used for setting the time of alarm event duration for output activation and minimum time of output reaction. Both times can be set in range from 0 ... 900 seconds.

Symbol	Description	Symbol	Description	Symbol	Description
U 1	phase voltage in L1	U 3 THD	voltage THD in phase L3	11	11 th harmonics of voltage
U 2	phase voltage in L2	I 1 THD	current THD in phase L1	13	13 th harmonics of voltage
U 3	phase voltage in L3	I 2 THD	current THD in phase L2	15	15 th harmonics of voltage
U 1-2	phase to phase voltage L1 – L2	I 3 THD	current THD in phase L3	17	17 th harmonics of voltage
U 1-3	phase to phase voltage L1 – L3	1 cosφ	cosφ in phase L1	19	19 th harmonics of voltage
U 2-3	phase to phase voltage L2 – L3	2 cosφ	cosφ in phase L2	harmonics available for all phases	
I 1	current in phase L1	3 cosφ	cosφ in phase L3	S	three-phase active power
I 2	current in phase L2	Fr	system frequency	P	three-phase apparent power
I 3	current in phase L3	3	3 rd harmonics of voltage	L	three-phase L reactive power
I n	current in N wire	5	5 th harmonics of voltage	C	three-phase C reactive power
U 1 THD	voltage THD in phase L1	7	7 th harmonics of voltage		
U 2 THD	voltage THD in phase L2	9	9 th harmonics of voltage		

Table 8. List of available alarm events

7. Normal monitoring mode

Standard operation status of the device is monitoring of electrical parameters. Monitored parameters are logically grouped and shown within one screen and sort to the set of related screens. There are 8 groups or better say levels according to the chapter 7.5.

7.1. Operation and symbol meanings

Display of the device is multifunction with symbols which introduce and specify shown information. Movement between groups (levels) of related screens is by pressing the key ▲. Within the (group) level, particular screens are browsed by pressing the key ▼. Levels are not closed so when the last screen of the currently displayed level is reached, other press of key ▼ moves to the first screen of next level.

From any screen at any level it is possible turn back to the first screen (phase voltage) by pressing the key **ESC**.

7.2. Maximum and minimum values

For all measured parameters the maximum reached values are kept in the memory. For several parameters the minimum of measured value is kept too. For presenting the maximum value one short press of key **SET** is needed. Maximum values are symbolized by symbol ▲ before the displayed number. Second short press of key **SET** displays the minimum values if available. Minimum values are symbolized by symbol ▼ before the displayed number. Third short press of key **SET** will turn back to the instantaneous measurement.

7.3. Demand values

For displaying the demand values of phase current, three-phase apparent power and three-phase active power it is necessary go to the screen of appropriate parameter and press the key **SET** twice. Demand value is introduced by displayed symbols ▲ and ▼ at the same time.

Since the demand value is four-quadrant the demand value of consumption is introduced only by symbols ▲ and ▼. For distribution the value is introduced by negative sign between symbols ▲ and ▼.

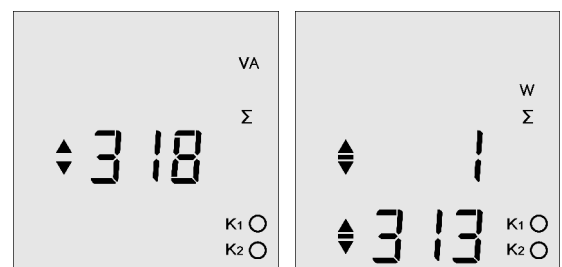

7.4. Energy counters

PLA33 measures all energies in consumption and supply direction, so there are six counters divided to the two groups. First group of three counters (active energy, reactive inductive energy, reactive capacitive energy) is for consumed energy and it is introduced by symbol ▲ shown on the first line of displayed total energy number.

Second group of three counters (active energy, reactive inductive energy, reactive capacitive energy) is for supplied energy and it is introduced by symbol ▼ shown on the first line of displayed total energy number.

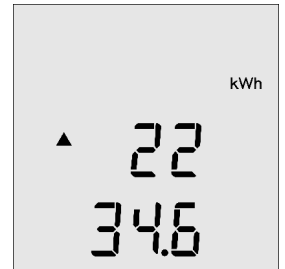

Note

*Erasing of all energy counters is possible in the configuration menu **P_2** by simultaneous pressing of buttons ▲ and ▼ or from PC by usage of PMS software.*

7.5. Monitoring screens

Meaning of each screen is easily identified by usage of standard ISO symbols and value parameters. Every displayed parameter value is shown with its variable.

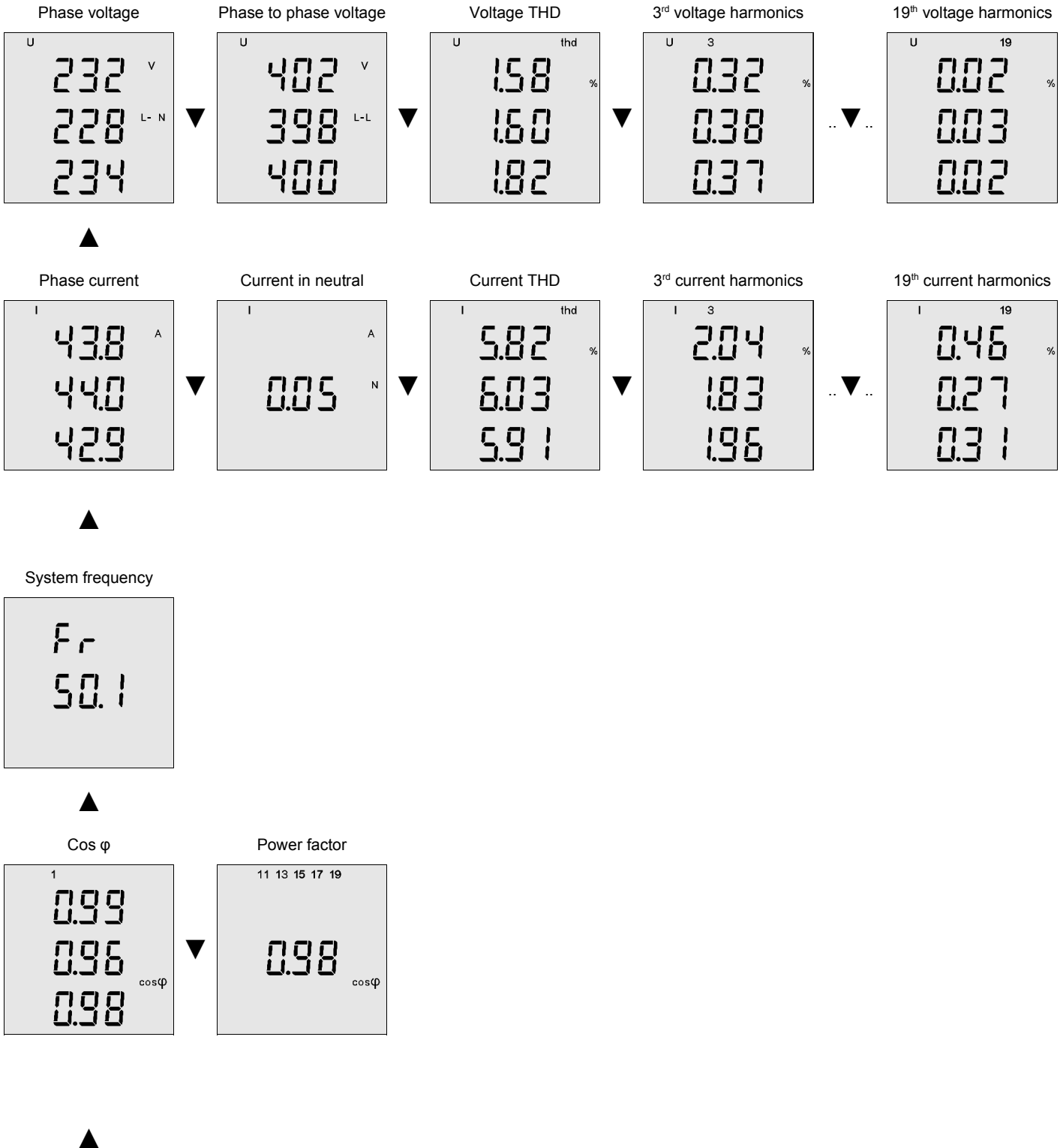

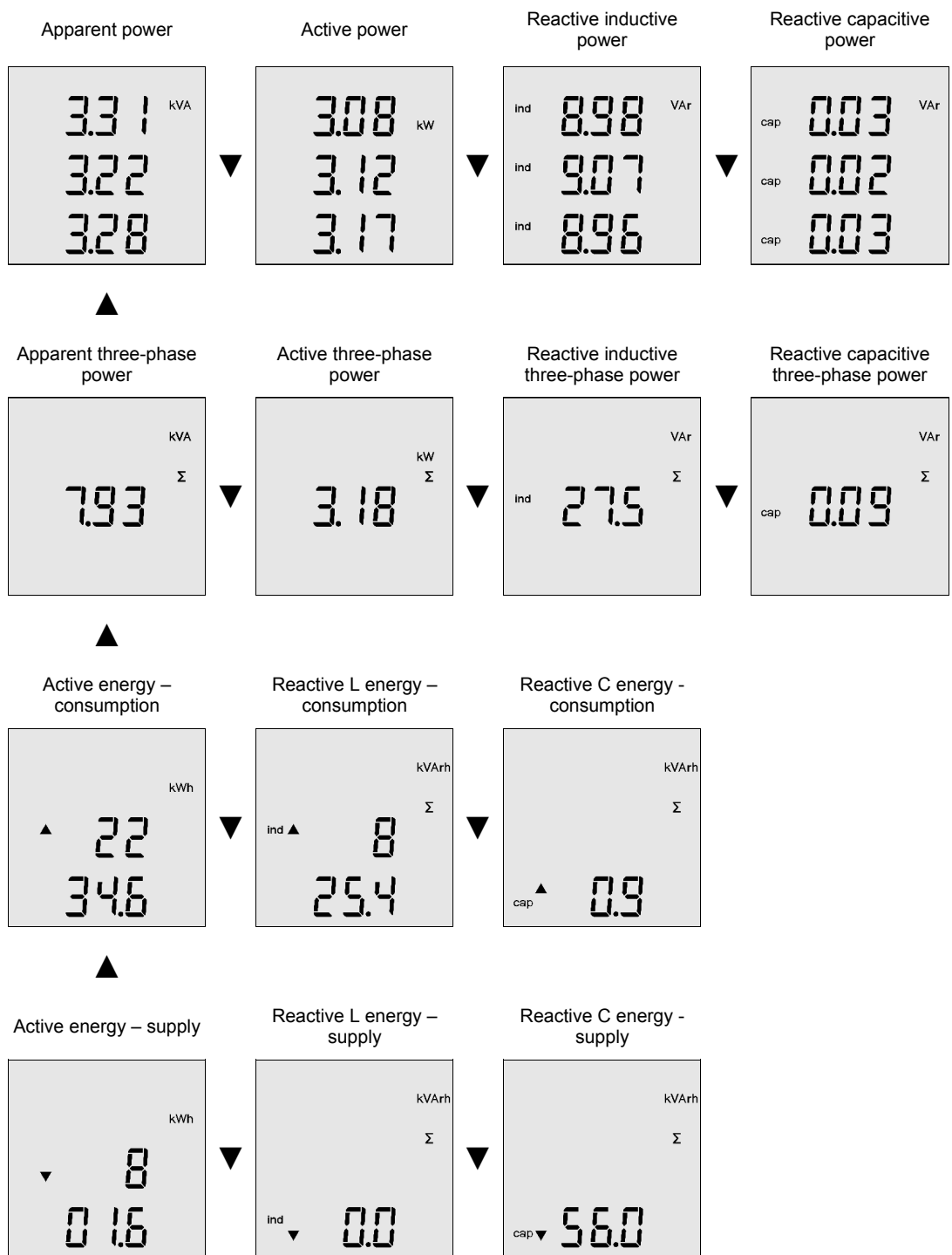

8. Technical features

Parameter	Value
Supply voltage	230 VAC, 50 Hz (+10%,-15%)
Frequency	45 ... 65 Hz
Current measuring range	0,01 ... 5,3 A
Voltage measuring range L - N	0 ... 300 VAC
Power consumption	1,5 VA
Measurement accuracy	0,5 MR
Number of output / input	2
Output type	NPN transistor free potential optical insulated
Maximum voltage for output usage	24 VDC
Maximum output load capability	100 mA
Input type	optical insulated free potential
Maximum input voltage	24 VDC
Maximum input consumption	10 mA
Voltage transformer ratio	1 ... 1500
Current transformer ratio	1 ... 1500
Event memory	20 events *
Data memory for measured parameters	512 MB **
Communication port	RS485 (optional) *
Communication protocol	MODBUS RTU *
Communication speed	9,6 / 19,2 / 38,4 / 57,6 / 115 kBd *
Temperature limit	-30°C ... +70°C
Front panel	96 x 96 mm
Panel cutout	92 x 92 mm
Site depth	55 mm
Weight	620 g (including packaging)
Protection degree	IP20 rear cover / IP54 front panel

* only PLA33C and PLA33CM variant

** only PLA33CM variant